

Article number: 208050251

Description: E+G Sphericalwasher male DIN 6319-25-C-NI
Stainless Steel 1.4305

Measures

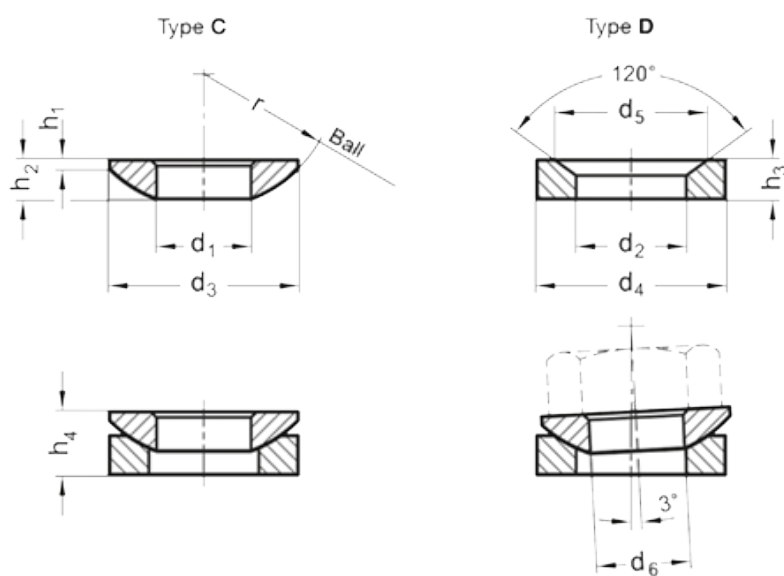

$d_1 = 25.0$

$d_3 = 44$

$d_6 = M24$

$H_1 = 2.4$

$H_2 = 8.2$

$H_4 = 15.2$

$r = 32$